

Data sheet | Item number: 831-1208/306-000

1-conductor male connector; lever; Push-in CAGE CLAMP®; 10 mm²; Pin spacing 7.62 mm; 8-pole; 100% protected against mismatching; DIN-35 rail /panel mounting; 10,00 mm²; light gray

www.wago.com/831-1208_306-000

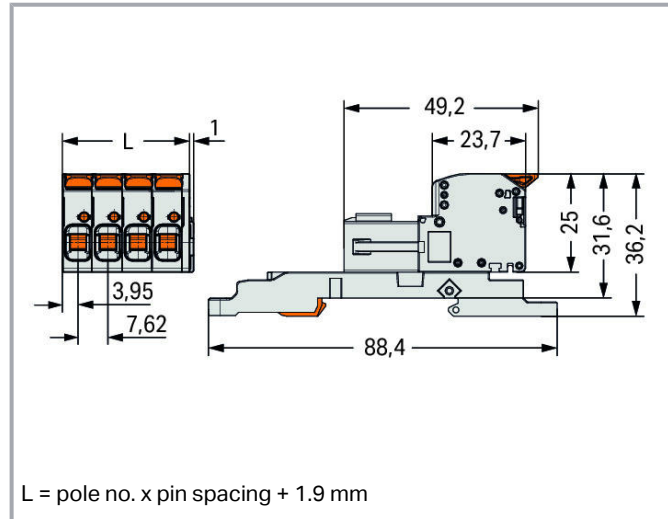
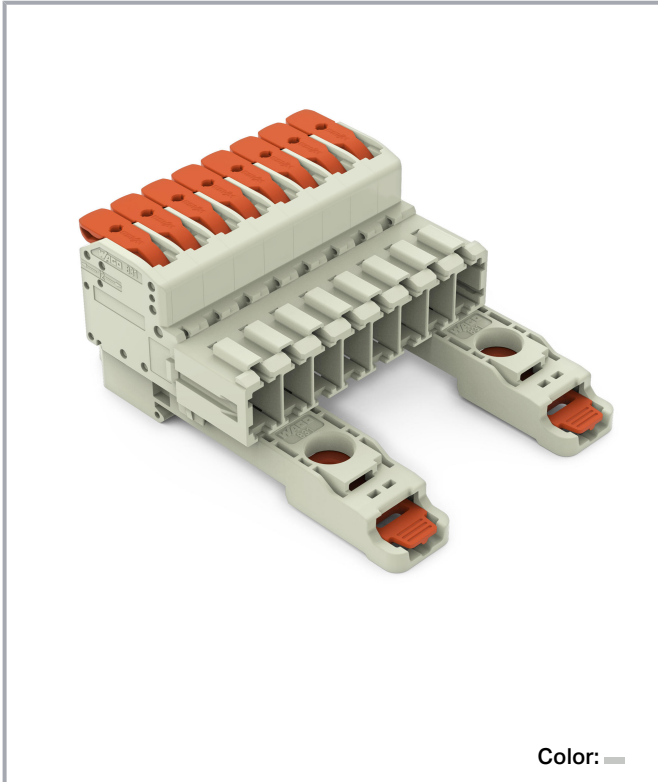

Item description

- Intuitive and tool-free lever actuation
- Universal connection for all conductor types
- Push-in terminations of solid and ferruled conductors
- Test slot 0° and 90° to conductor entry
- 100 % protected against mismatching
- Coding via coding fingers

Note:

Available April 2021

Safety information 1:

The MCS – MULTI CONNECTION SYSTEM includes connectors without breaking capacity in accordance with DIN EN 61984. When used as intended, these connectors must not be connected/disconnected when live or under load. The circuit design should ensure header pins, which can be touched, are not live when unmated.

Subject to changes. Please also observe the further product documentation!

WAGO Corporation
Germantown, WI 53022
Phone: 1-800-DIN-RAIL (346-7245) | Fax: (262) 255-6222
Email: info.us@wago.com | Web: www.wago.us

Do you have any questions about our products?
We are always happy to take your call at (262) 255-6222 or 1 800-DIN-RAIL.



Data

Electrical data

IEC Approvals

| | |
|-----------------------------|---|
| Ratings per | IEC/EN 60664-1 |
| Rated voltage (III / 3) | 800 V |
| Rated surge voltage (III/3) | 8 kV |
| Rated voltage (III/2) | 1000 V |
| Rated surge voltage (III/2) | 8 kV |
| Nominal voltage (II/2) | 1000 V |
| Rated surge voltage (II/2) | 8 kV |
| Rated current | 41 A |
| Legend (ratings) | (III / 2) $\hat{=}$ Overvoltage category III / Pollution degree 2 |

Connection data

| | |
|---|---|
| Connection technology | Push-in CAGE CLAMP® |
| Actuation type | Lever |
| Solid conductor | 0.5 ... 10 mm ² / 20 ... 8 AWG |
| Fine-stranded conductor | 0.5 ... 10 mm ² / 20 ... 8 AWG |
| Fine-stranded conductor; with insulated ferrule | 0.5 ... 6 mm ² |
| Fine-stranded conductor; with uninsulated ferrule | 0.5 ... 6 mm ² |
| Strip length | 11 ... 13 mm / 0.43 ... 0.51 inch |
| Pole No. | 8 |
| Total number of potentials | 8 |
| Number of connection types | 1 |
| Number of levels | 1 |

Physical data

| | |
|-------------|----------------------|
| Pin spacing | 7.62 mm / 0.3 inch |
| Width | 63.9 mm / 2.5 inch |
| Depth | 88.4 mm / 3.480 inch |

Mechanical data

| | |
|---------------|-------------------------------|
| Mounting type | DIN-35 rail Panel mounting |
|---------------|-------------------------------|

Subject to changes. Please also observe the further product documentation!

WAGO Corporation
Germantown, WI 53022
Phone: 1-800-DIN-RAIL (346-7245) | Fax: (262) 255-6222
Email: info.us@wago.com | Web: www.wago.us

Do you have any questions about our products?
We are always happy to take your call at (262) 255-6222 or 1 800-DIN-RAIL.

Plug-in connection

| | |
|------------------------------------|---------------------|
| Contact type (pluggable connector) | Male connector/plug |
| Connector (connection type) | for conductor |
| Mismating protection | Yes |
| Locking of plug-in connection | Without |

Material data

| | |
|-----------------------------|--|
| Color | light gray |
| Material group | I |
| Insulation material | Polyamide (PA66) |
| Flammability class per UL94 | V0 |
| Clamping spring material | Chrome nickel spring steel (CrNi) |
| Contact material | Electrolytic copper (E _{Cu}) |
| Contact plating | tin-plated |
| Color of actuator | orange |
| Weight | 63 g |

Environmental requirements

| | |
|-------------------------|-----------------|
| Limit temperature range | -60 ... +105 °C |
|-------------------------|-----------------|

Commercial data

| | |
|-----------------------|---------------|
| Packaging type | BOX |
| Country of origin | DE |
| GTIN | 4055144062946 |
| Customs tariff number | 8536694040 |



Approvals / Certificates

UL-Approvals

| Logo | Approval | Additional Approval Text | Certificate name |
|--|--------------------------------------|--------------------------|------------------|
|  | UR Underwriters Laboratories Inc. | UL 1059 | E45172 |

Subject to changes. Please also observe the further product documentation!

Counterpart

| | | |
|--|---|--|
|  | Item no.831-1108 1-conductor female connector; 100% protected against mismatching; lever; 10 mm ² ; Pin spacing 7.62 mm; 8-pole; 10,00 mm ² ; light gray | www.wago.com/831-1108 |
|  | Item no.831-1108/037-000 1-conductor female connector; 100% protected against mismatching; lever; Locking lever; 10 mm ² ; Pin spacing 7.62 mm; 8-pole; 10,00 mm ² ; light gray | www.wago.com/831-1108/037-000 |
|  | Item no.831-1108/038-000 1-conductor female connector; 100% protected against mismatching; lever; Locking lever; 10 mm ² ; Pin spacing 7.62 mm; 8-pole; 10,00 mm ² ; light gray | www.wago.com/831-1108/038-000 |

Optional accessories

Ferrules

















| | | |
|--|--|--|
|  | Item no.: 216-101 Ferrule; Sleeve for 0.5 mm ² / AWG 22; uninsulated; electro-tin plated; silver-colored | www.wago.com/216-101 |
|  | Item no.: 216-102 Ferrule; Sleeve for 0.75 mm ² / AWG 20; uninsulated; electro-tin plated; silver-colored | www.wago.com/216-102 |
|  | Item no.: 216-103 Ferrule; Sleeve for 1 mm ² / AWG 18; uninsulated; electro-tin plated | www.wago.com/216-103 |
|  | Item no.: 216-104 Ferrule; Sleeve for 1.5 mm ² / AWG 16; uninsulated; electro-tin plated; silver-colored | www.wago.com/216-104 |
|  | Item no.: 216-106 Ferrule; Sleeve for 2.5 mm ² / AWG 14; uninsulated; electro-tin plated; silver-colored | www.wago.com/216-106 |
|  | Item no.: 216-107 Ferrule; Sleeve for 4 mm ² / AWG 12; uninsulated; electro-tin plated | www.wago.com/216-107 |
|  | Item no.: 216-108 Ferrule; Sleeve for 6 mm ² / AWG 10; uninsulated; electro-tin plated; silver-colored | www.wago.com/216-108 |
|  | Item no.: 216-121 Ferrule; Sleeve for 0.5 mm ² / AWG 22; uninsulated; electro-tin plated; silver-colored | www.wago.com/216-121 |
|  | Item no.: 216-122 Ferrule; Sleeve for 0.75 mm ² / AWG 20; uninsulated; electro-tin plated; silver-colored | www.wago.com/216-122 |
|  | Item no.: 216-123 Ferrule; Sleeve for 1 mm ² / AWG 18; uninsulated; electro-tin plated; silver-colored | www.wago.com/216-123 |
|  | Item no.: 216-124 Ferrule; Sleeve for 1.5 mm ² / AWG 16; uninsulated; electro-tin plated | www.wago.com/216-124 |

Subject to changes. Please also observe the further product documentation!

| | | |
|--|---|--|
|  | Item no.: 216-131 Ferrule; Sleeve for 0.25 mm ² / AWG 24; uninsulated; electro-tin plated; silver-colored | www.wago.com/216-131 |
|  | Item no.: 216-132 Ferrule; Sleeve for 0.34 mm ² / AWG 24; uninsulated; electro-tin plated | www.wago.com/216-132 |
|  | Item no.: 216-141 Ferrule; Sleeve for 0.5 mm ² / 20 AWG; uninsulated; electro-tin plated; electrolytic copper; gastight crimped; acc. to DIN 46228, Part 1/08.92 | www.wago.com/216-141 |
|  | Item no.: 216-142 Ferrule; Sleeve for 0.75 mm ² / 18 AWG; uninsulated; electro-tin plated; electrolytic copper; gastight crimped; acc. to DIN 46228, Part 1/08.92 | www.wago.com/216-142 |
|  | Item no.: 216-143 Ferrule; Sleeve for 1 mm ² / AWG 18; uninsulated; electro-tin plated; electrolytic copper; gastight crimped; acc. to DIN 46228, Part 1/08.92 | www.wago.com/216-143 |
|  | Item no.: 216-144 Ferrule; Sleeve for 1.5 mm ² / AWG 16; uninsulated; electro-tin plated; electrolytic copper; gastight crimped; acc. to DIN 46228, Part 1/08.92; silver-colored | www.wago.com/216-144 |
|  | Item no.: 216-151 Ferrule; Sleeve for 0.25 mm ² / AWG 24; uninsulated; electro-tin plated | www.wago.com/216-151 |
|  | Item no.: 216-152 Ferrule; Sleeve for 0.34 mm ² / AWG 24; uninsulated; electro-tin plated | www.wago.com/216-152 |
|  | Item no.: 216-201 Ferrule; Sleeve for 0.5 mm ² / 20 AWG; insulated; electro-tin plated; white | www.wago.com/216-201 |
|  | Item no.: 216-202 Ferrule; Sleeve for 0.75 mm ² / 18 AWG; insulated; electro-tin plated; gray | www.wago.com/216-202 |
|  | Item no.: 216-203 Ferrule; Sleeve for 1 mm ² / AWG 18; insulated; electro-tin plated; red | www.wago.com/216-203 |
|  | Item no.: 216-204 Ferrule; Sleeve for 1.5 mm ² / AWG 16; insulated; electro-tin plated; black | www.wago.com/216-204 |
|  | Item no.: 216-205 Ferrule; Sleeve for 2.08 mm ² / AWG 14; insulated; electro-tin plated; yellow | www.wago.com/216-205 |
|  | Item no.: 216-206 Ferrule; Sleeve for 2.5 mm ² / AWG 14; insulated; electro-tin plated; blue | www.wago.com/216-206 |
|  | Item no.: 216-207 Ferrule; Sleeve for 4 mm ² / AWG 12; insulated; electro-tin plated; gray | www.wago.com/216-207 |
|  | Item no.: 216-208 Ferrule; Sleeve for 6 mm ² / AWG 10; insulated; electro-tin plated; electrolytic copper; gastight crimped; acc. to DIN 46228, Part 4/09.90; yellow | www.wago.com/216-208 |
|  | Item no.: 216-221 Ferrule; Sleeve for 0.5 mm ² / 20 AWG; insulated; electro-tin plated; white | www.wago.com/216-221 |

Item no.: 216-222

Subject to changes. Please also observe the further product documentation!

| | | |
|---|--|--|
|  | Ferrule; Sleeve for 0.75 mm ² / 18 AWG; insulated; electro-tin plated; gray | www.wago.com/216-222 |
|  | Item no.: 216-223 Ferrule; Sleeve for 1 mm ² / AWG 18; insulated; electro-tin plated; red | www.wago.com/216-223 |
|  | Item no.: 216-224 Ferrule; Sleeve for 1.5 mm ² / AWG 16; insulated; electro-tin plated; black | www.wago.com/216-224 |
|  | Item no.: 216-241 Ferrule; Sleeve for 0.5 mm ² / 20 AWG; insulated; electro-tin plated; electrolytic copper; gastight crimped; acc. to DIN 46228, Part 4/09.90; white | www.wago.com/216-241 |
|  | Item no.: 216-242 Ferrule; Sleeve for 0.75 mm ² / 18 AWG; insulated; electro-tin plated; electrolytic copper; gastight crimped; acc. to DIN 46228, Part 4/09.90; gray | www.wago.com/216-242 |
|  | Item no.: 216-243 Ferrule; Sleeve for 1 mm ² / AWG 18; insulated; electro-tin plated; electrolytic copper; gastight crimped; acc. to DIN 46228, Part 4/09.90; red | www.wago.com/216-243 |
|  | Item no.: 216-244 Ferrule; Sleeve for 1.5 mm ² / AWG 16; insulated; electro-tin plated; electrolytic copper; gastight crimped; acc. to DIN 46228, Part 4/09.90; black | www.wago.com/216-244 |
|  | Item no.: 216-246 Ferrule; Sleeve for 2.5 mm ² / AWG 14; insulated; electro-tin plated; electrolytic copper; gastight crimped; acc. to DIN 46228, Part 4/09.90; blue | www.wago.com/216-246 |
|  | Item no.: 216-262 Ferrule; Sleeve for 0.75 mm ² / 18 AWG; insulated; electro-tin plated; electrolytic copper; gastight crimped; acc. to DIN 46228, Part 4/09.90; gray | www.wago.com/216-262 |
|  | Item no.: 216-263 Ferrule; Sleeve for 1 mm ² / AWG 18; insulated; electro-tin plated; electrolytic copper; gastight crimped; acc. to DIN 46228, Part 4/09.90; red | www.wago.com/216-263 |
|  | Item no.: 216-264 Ferrule; Sleeve for 1.5 mm ² / AWG 16; insulated; electro-tin plated; electrolytic copper; gastight crimped; acc. to DIN 46228, Part 4/09.90; black | www.wago.com/216-264 |
|  | Item no.: 216-266 Ferrule; Sleeve for 2.5 mm ² / AWG 14; insulated; electro-tin plated; electrolytic copper; gastight crimped; acc. to DIN 46228, Part 4/09.90; blue | www.wago.com/216-266 |
|  | Item no.: 216-267 Ferrule; Sleeve for 4 mm ² / AWG 12; insulated; electro-tin plated; electrolytic copper; gastight crimped; acc. to DIN 46228, Part 4/09.90; gray | www.wago.com/216-267 |
|  | Item no.: 216-284 Ferrule; Sleeve for 1.5 mm ² / AWG 16; insulated; electro-tin plated; electrolytic copper; gastight crimped; acc. to DIN 46228, Part 4/09.90; black | www.wago.com/216-284 |
|  | Item no.: 216-286 Ferrule; Sleeve for 2.5 mm ² / AWG 14; insulated; electro-tin plated; electrolytic copper; gastight crimped; acc. to DIN 46228, Part 4/09.90; blue | www.wago.com/216-286 |
|  | Item no.: 216-287 Ferrule; Sleeve for 4 mm ² / AWG 12; insulated; electro-tin plated; electrolytic copper; gastight crimped; acc. to DIN 46228, Part 4/09.90; gray | www.wago.com/216-287 |
| | Item no.: 216-288 | |

Subject to changes. Please also observe the further product documentation!



Ferrule; Sleeve for 6 mm² / AWG 10; insulated; electro-tin plated; electrolytic copper; gastight crimped; www.wago.com/216-288
acc. to DIN 46228, Part 4/09.90; yellow

Downloads

Documentation

Additional Information

| | | | |
|------------------------|-------------|---------------|----------|
| Technical explanations | Apr 3, 2019 | pdf 2.0 MB | Download |
|------------------------|-------------|---------------|----------|

Environmental Product Compliance

Compliance Search

| | | |
|--|-----|----------|
| Environmental Product Compliance 831-1208/306-000 | URL | Download |
| 1-conductor male connector; lever; Push-in CAGE CLAMP®; 10 mm ² ; Pin spacing 7.62 mm; 8-pole; 100% protected against mismatching; DIN-35 rail/panel mounting; 10,00 mm ² ; light gray | | |

Installation Notes

Product family

<i>MCS</i> MAXI 6
[Show all products from the family](#)

Subject to changes. Please also observe the further product documentation!

WAGO Corporation
Germantown, WI 53022
Phone: 1-800-DIN-RAIL (346-7245) | Fax: (262) 255-6222
Email: info.us@wago.com | Web: www.wago.us

Do you have any questions about our products?
We are always happy to take your call at (262) 255-6222 or 1 800-DIN-RAIL.